



EFFICIENT WORK



CHT/EW CVT/EW



**INDUSTRIAL
BRUSHLESS
MOTOR E.C.**



CHT

CVT



VARIABLE SPEED DRIVE
VSD: Variable Speed Drive
Drive: VSD1/B
VSD3/B
Supply included with fan

CONTROL
Supply optional accessory

SUPPLY
VSD1/B:
220-240 V 50/60 Hz
VSD3/B:
380-415 V 50/60 Hz

400°C/2h centrifugal roof-mounted extractors with horizontal or vertical outlet air, fitted with industrial Brushless motor E.C.

CHT/EW: 400°C/2h centrifugal roof-mounted extractors with horizontal outlet air, hood in aluminium, fitted with industrial Brushless motor E.C.

CVT/EW: 400°C/2h centrifugal roof-mounted extractors with vertical outlet air, hood in aluminium, fitted with industrial Brushless motor E.C.

Fan:

- Galvanised sheet steel base plate.
- Impeller with backward-curved blades made from galvanised sheet steel
- Bird protection guard.
- Aluminium rain deflector hood

Motor and electronic variable speed:

- High-efficiency Industrial Brushless Motors E.C., fitted with electronic variable speed (VSD), adjustable via external control input 0-10V.
- It is advisable to install an electronic variable speed drive (VSD) outside the working area.
- The external signal can be supplied through a manual or automatic control with 0-10 V output.
- Electronic variable speed drive (VSD), available with single-phase 220-240 V 50/60 Hz input (VSD1/B type) or three-

phase 380-415 V 50/60 Hz (VSD3/B type).

- By default, the electronic variable speed drive (VSD) is delivered programmed for constant speed.
- Working fan temperature: -25 °C +60 °C.
- Working temperature (VSD): -25 °C +50 °C.

Finish:

- Anticorrosive galvanized sheet steel



Order code with variable speed drive (VSD) included

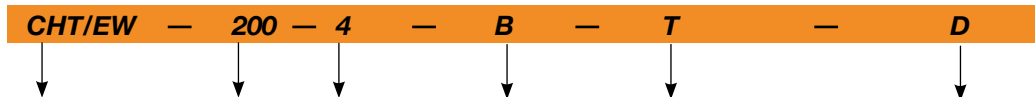

CHT/EW: 400°C/2h high-efficiency centrifugal roof fans, "Efficient work", with horizontal outlet air

Impeller size

Number of poles:
4=1410 r/min
6=960 r/min

Motors:
Industrial
Brushless E.C.

M: Fitted with VSD1/B, electronic variable speed, single phase power supply 220-240 V 50/60 Hz.

T: Fitted with VSD3/B, electronic variable speed, three-phase power supply 380-415 V 50/60 Hz.

D: Standard version, VSD supplied programmed for constant speed.
P: Supplied with VSD programmed for pressure control and Si-Presión pressure transmitter
K: Supplied with VSD programmed for pressure control and built into a BOXPRES KIT/B box.

CVT/EW: 400°C/2h high-efficiency centrifugal roof fans, "Efficient work", with vertical outlet air

Technical characteristics

Model	Speed min/max (r/min)	Single-phase VSD 230 V 50/60 Hz		Three-phase VSD 400 V 50/60 Hz		Maximum electrical power (W)	Maximum airflow min/max (m³/h)	Sound pressure level Lp dB(A)		Weight approx. (Kg)
		Maximum current input (A)	Model VSD	Maximum current input (A)	Model VSD			Inlet min/max	Outlet min/max	
CHT/EW CVT/EW 200-4	300 / 1410	1.14	VSD1/B-0.37	0.34	VSD3/B-0.75	140	310 / 1450	3 / 37	9 / 43	25
CHT/EW CVT/EW 225-4	300 / 1410	1.44	VSD1/B-0.37	0.42	VSD3/B-0.75	175	445 / 2100	7 / 41	13 / 47	25
CHT/EW CVT/EW 225-6	300 / 960	0.93	VSD1/B-0.37	0.27	VSD3/B-0.75	110	440 / 1400	5 / 30	11 / 36	26
CHT/EW CVT/EW 250-4	300 / 1410	2.79	VSD1/B-0.37	0.82	VSD3/B-0.75	340	660 / 3100	11 / 45	16 / 50	34
CHT/EW CVT/EW 250-6	300 / 960	1.17	VSD1/B-0.37	0.34	VSD3/B-0.75	140	625 / 2000	8 / 33	15 / 40	35
CHT/EW CVT/EW 315-4	300 / 1410	5.82	VSD1/B-0.75	1.37	VSD3/B-1.5	660	1055 / 4950	14 / 48	20 / 54	39
CHT/EW CVT/EW 315-6	300 / 960	2.13	VSD1/B-0.37	0.62	VSD3/B-0.75	255	1000 / 3200	12 / 37	18 / 43	39
CHT/EW CVT/EW 400-4	300 / 1410	7.94	VSD1/B-0.75	1.87	VSD3/B-1.5	905	1490 / 7000	21 / 55	27 / 61	57
CHT/EW CVT/EW 400-6	300 / 960	4.28	VSD1/B-0.75	1.00	VSD3/B-1.5	480	1405 / 4500	19 / 44	25 / 50	56
CHT/EW CVT/EW 450-4	300 / 1410	15.89	VSD1/B-1.5	3.74	VSD3/B-1.5	1825	2170 / 10200	25 / 59	30 / 64	66
CHT/EW CVT/EW 450-6	300 / 960	5.64	VSD1/B-0.75	1.32	VSD3/B-1.5	635	2155 / 6900	22 / 47	29 / 54	59
CHT/EW CVT/EW 500-6	300 / 960	11.51	VSD1/B-1.5	2.71	VSD3/B-1.5	1325	3750 / 12000	26 / 51	32 / 57	103



Acoustic features

The specified values are determined according to free field measurements of pressure and sound levels in dB(A) at a distance of 6 m.

Sound power Lw(A) spectrum in dB(A) via frequency band in Hz.

Inlet.								Outlet.								
Values taken at the inlet with 2/3 of the maximum airflow (2/3Qmax).								Values taken at outlet with 2/3 of the maximum airflow (2/3Qmax).								
Model	63	125	250	500	1000	2000	4000	8000	63	125	250	500	1000	2000	4000	8000
200-4	35	41	52	55	56	52	50	44	39	44	58	60	61	61	56	51
225-4	42	51	56	56	60	59	52	46	41	50	60	64	67	64	57	51
225-6	31	40	45	45	49	48	41	35	30	39	49	53	56	53	46	40
250-4	46	55	60	60	64	63	56	50	44	53	63	67	70	67	60	54
250-6	34	43	48	48	52	51	44	38	34	43	53	57	60	57	50	44
315-4	50	56	62	62	65	68	59	53	49	61	69	71	72	72	64	56
315-6	39	45	51	51	54	57	48	42	38	50	58	60	61	61	53	45
400-4	62	69	74	74	78	77	70	65	60	72	80	82	83	80	73	65
400-6	46	52	58	58	61	64	55	49	45	57	65	67	68	68	60	52
450-4	62	69	74	74	78	77	70	65	60	72	80	82	83	80	73	65
450-6	50	57	62	62	66	65	58	53	50	62	70	72	73	70	63	55
500-6	54	60	65	66	70	69	62	55	50	64	72	76	75	72	66	60

Dimensions in mm

CHT/EW

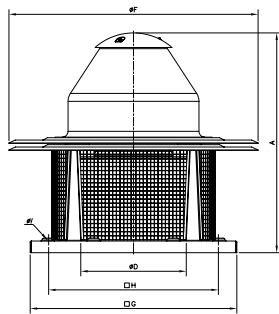

CHT/EW	A	øD*	øF	G	H	øl
200	552	250	570	450	360	12
225	570	250	570	450	360	12
250	632	355	726	560	450	12
315	682	355	726	560	450	12
400	755	500	856	710	590	12
450	770	500	856	710	590	12
500	846	630	1075	900	750	14

CVT/EW

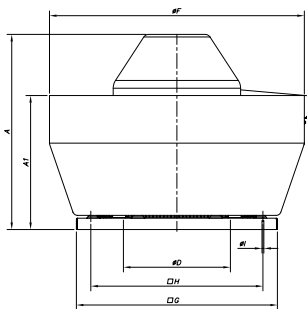

CVT/EW	A	A1	øD*	øF	G	H	øl
200	500	308	250	530	450	360	12
225	517	308	250	530	450	360	12
250	580	380	355	705	560	450	12
315	630	380	355	705	560	450	12
400	690	475	500	900	710	590	12
450	705	475	500	900	710	590	12
500	775	545	630	1100	900	750	14

Accessories

See accessories section



INT



BS
BSS



BAC



B



PA



MS



PT
PT/400



S



CONTROL UNITS
AND SENSORS



EFFICIENT WORK



Erp. Characteristic curves and ErP data

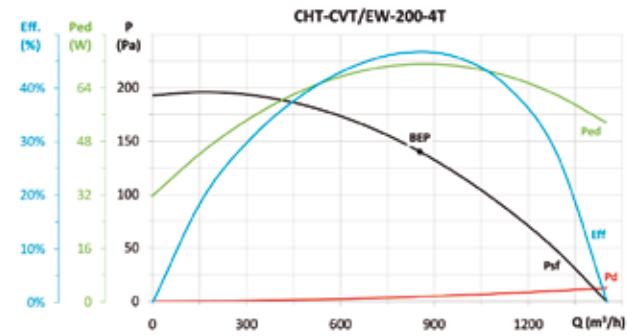

MC	EC	SR	Cc	η_b (%)*	N	[kW]	[m³/h]	[Pa]	[rpm]	VSD
C	S	-	-	-	-	0,071	853	140	1410	INCLUDED

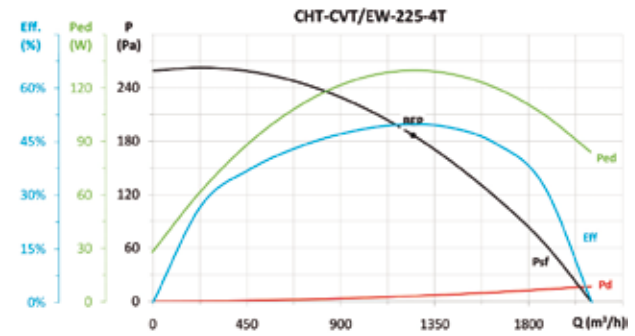

MC	EC	SR	Cc	η_b (%)*	N	[kW]	[m³/h]	[Pa]	[rpm]	VSD
C	S	1,00	1,15	57,3%	77,1	0,130	1247	187	1410	INCLUDED

* η_e (%) = Eff. (%) x Cc

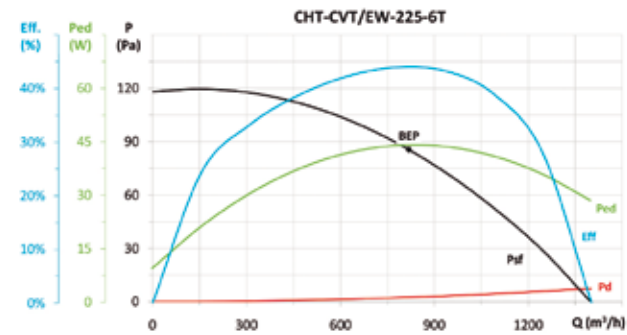

MC	EC	SR	Cc	η_b (%)*	N	[kW]	[m³/h]	[Pa]	[rpm]	VSD
C	S	-	-	-	-	0,044	818	86	960	INCLUDED

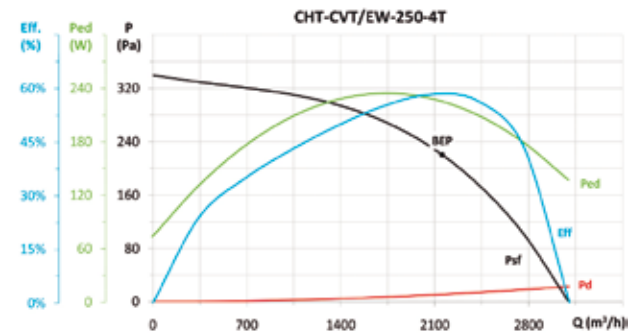

MC	EC	SR	Cc	η_b (%)*	N	[kW]	[m³/h]	[Pa]	[rpm]	VSD
C	S	1,00	1,13	66,3%	83,6	0,226	2156	220	1410	INCLUDED

* η_e (%) = Eff. (%) x Cc

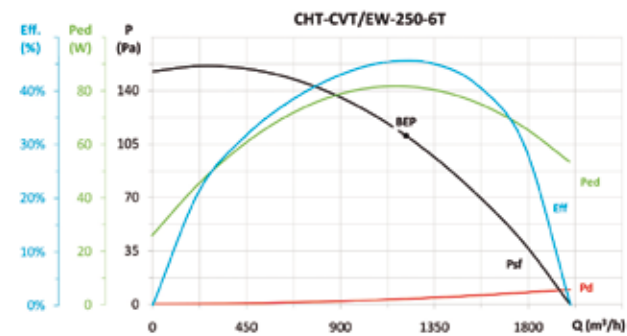

MC	EC	SR	Cc	η_b (%)*	N	[kW]	[m³/h]	[Pa]	[rpm]	VSD
C	S	-	-	-	-	0,082	1214	111	960	INCLUDED

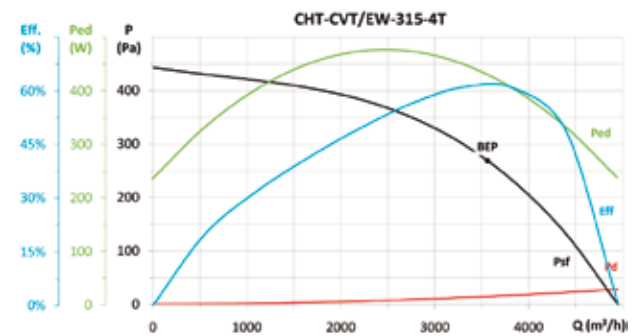

MC	EC	SR	Cc	η_b (%)*	N	[kW]	[m³/h]	[Pa]	[rpm]	VSD
C	S	1,00	1,11	68,8%	83,1	0,431	3562	269	1410	INCLUDED

* η_e (%) = Eff. (%) x Cc

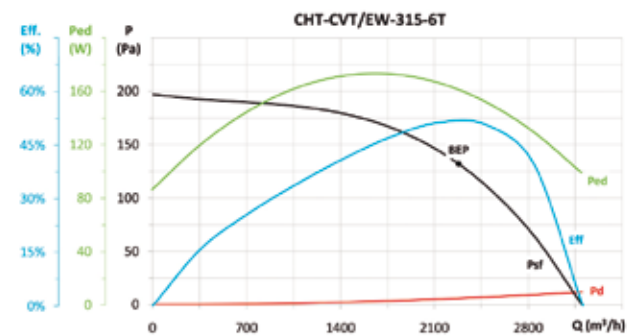

MC	EC	SR	Cc	η_b (%)*	N	[kW]	[m³/h]	[Pa]	[rpm]	VSD
C	S	1,00	1,14	59,2%	78,0	0,161	2281	132	960	INCLUDED

* η_e (%) = Eff. (%) x Cc

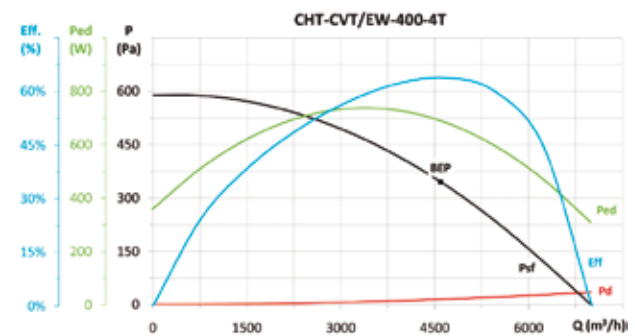

MC	EC	SR	Cc	η_b (%)*	N	[kW]	[m³/h]	[Pa]	[rpm]	VSD
C	S	1,00	1,10	70,2%	82,4	0,691	4594	345	1410	INCLUDED

* η_e (%) = Eff. (%) x Cc



Erp. Characteristic curves and ErP data

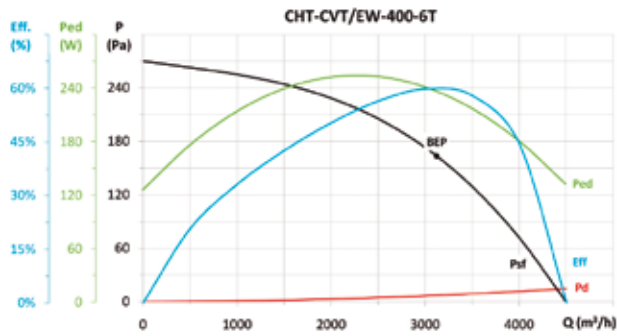

MC	EC	SR	Cc	η_b (%)*	N	[kW]	[m³/h]	[Pa]	[rpm]	VSD
C	S	1,00	1,13	67,9%	84,9	0,237	3124	164	960	INCLUDED

* η_e (%) = Eff. (%) x Cc

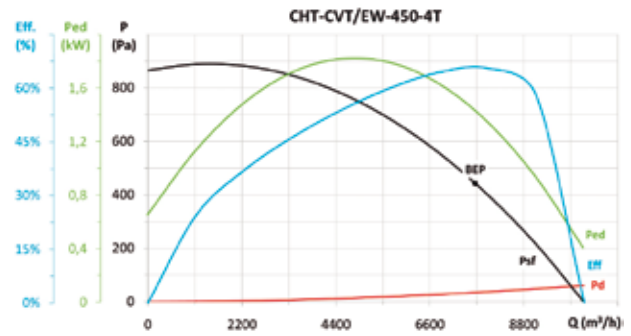

MC	EC	SR	Cc	η_b (%)*	N	[kW]	[m³/h]	[Pa]	[rpm]	VSD
C	S	1,00	1,08	70,8%	79,7	1,434	7663	443	1410	INCLUDED

* η_e (%) = Eff. (%) x Cc

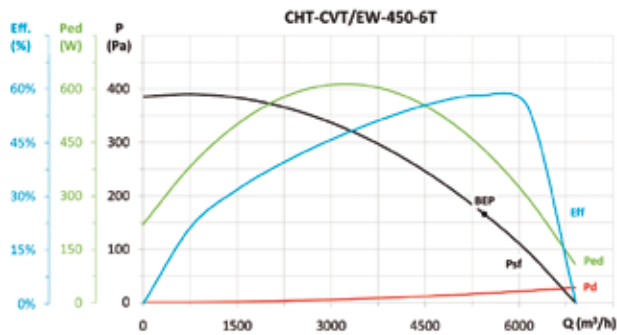

MC	EC	SR	Cc	η_b (%)*	N	[kW]	[m³/h]	[Pa]	[rpm]	VSD
C	S	1,00	1,11	64,8%	79,2	0,430	5449	165	960	INCLUDED

* η_e (%) = Eff. (%) x Cc

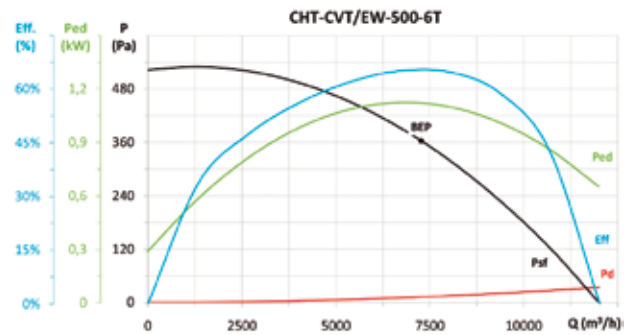

MC	EC	SR	Cc	η_b (%)*	N	[kW]	[m³/h]	[Pa]	[rpm]	VSD
C	S	1,00	1,08	71,0%	81,0	1,121	7265	364	960	INCLUDED

* η_e (%) = Eff. (%) x Cc